

Track System Specification

MT11G(A)

— MicroTrack T1 series



◎ Basic Parameters

- Material: AL6063, spraying surface
- Coating: Matte Black (RAL9005)
- Size: 112*16*89mm / 220*16*89mm
- IP grade: IP20
- CCT: 3000K,4000K optional
- CRI: 90
- SDCM: <3 Step
- Beam angle: 30°
- Light efficiency: 71 LM/W,71 LM/W
- Input voltage: DC48V
- Lighting direction: Downward
- Dimming method: Non-dimming,DALI-2,Tuya Bluetooth,CASAMBI
- Application: Indoor
- Certification: CE,UKCA,ROHS,Reach
- Warranty: 5 years

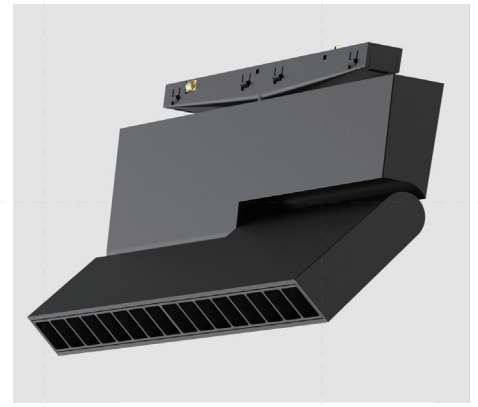

◎ Product mechanical data

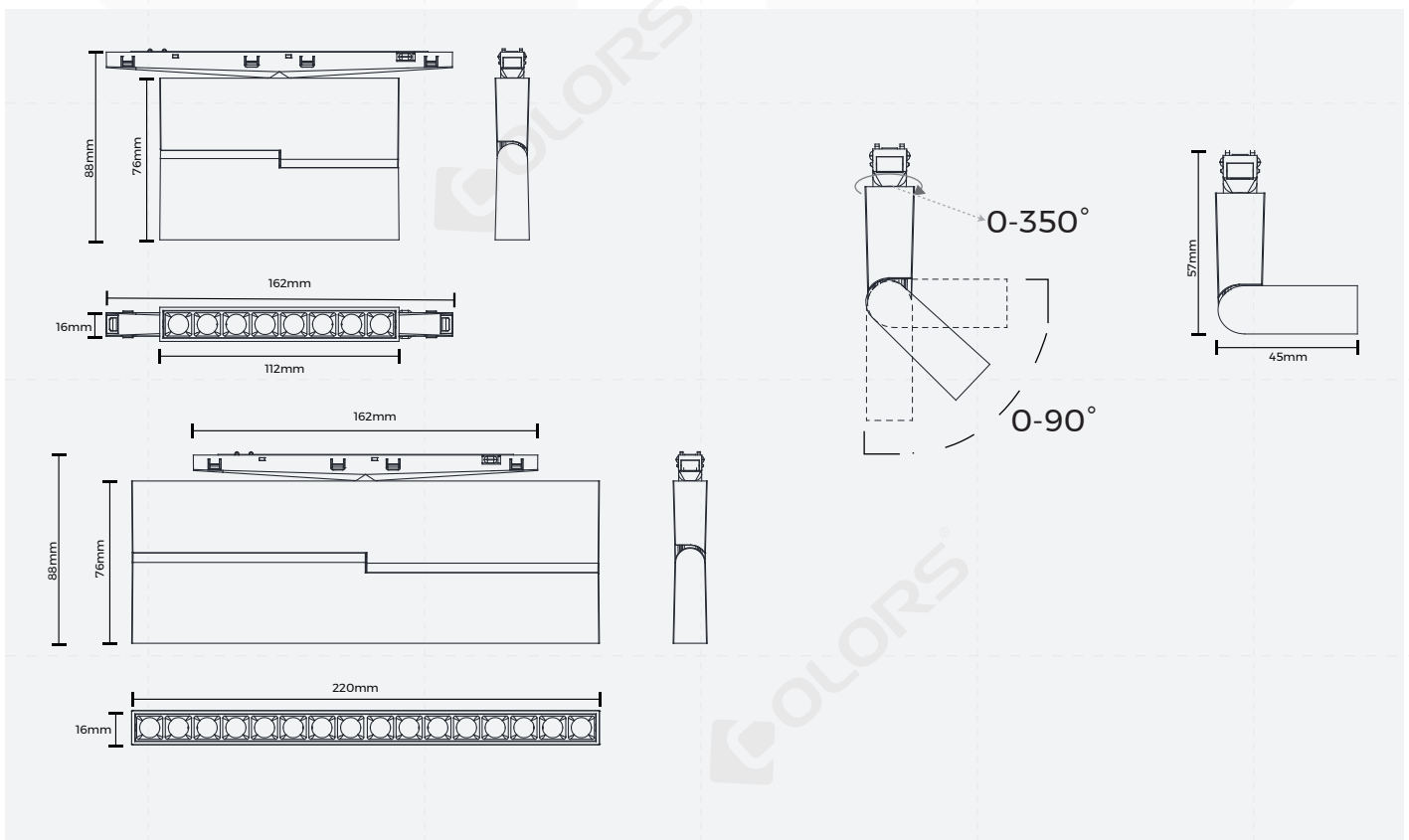

© Luminaire Parameters

Version	Model	Length	Input Voltage (V)	Max. Current (A)	Type Power (W)	Max. Power (W)	CRI	Beam Angle	CCT	Lumen (LM)
Normal	MT11G(A)	112mm	48VDC	0.183	7.0	8.8	>90	30°	3000K	455
									4000K	490
Normal	MT11G(A)	220mm	48VDC	0.367	14.0	17.6	>90	30°	3000K	910
									4000K	980

Note:

1. The output data is based on the testing result of Ra90,3000k luminaires;
2. The tolerance of output data can be vary up to 10%;
3. The output data is typical value.

© Optical Parameter

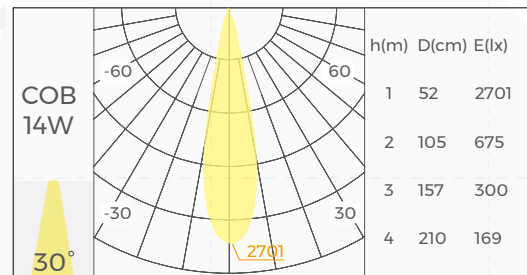
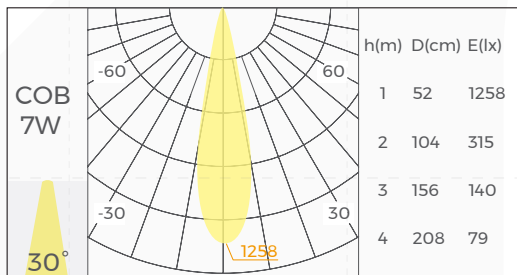

[Points to note]

⚡ 48V Power Supply

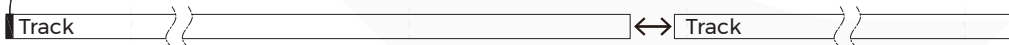

Total track Length ≤ 50M

⚡ 48V Power Supply











Max. Load ≤ 480W

Supplementary power supplies are needed beside the Spotlights module / Decorative module / Linear modular under below one conditions:

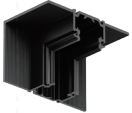
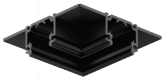
1. Load > 480W on the track
2. Total track length > 50M

© Accessories Information

Picture	Name	Model
	Trimless recessed track (13mm gypsum board)	TLS-MT11-RX0
	Ceiling track	TLS-MT11-SX0
	Pendant track	TLS-MT11-HX0
	Pendant track	TLS-MT11-SRX0
	φ1000mm 90° Ceiling curve track	TLS-MS111090
	Rail energization box	TLS-MT1101
	Horizontal corner power-on connectors	TLS-MT1102
	Flexible energized connectors	TLS-MT1103
	Rail energized connectors	TLS-MT1104
	Pendant accessory	TLS-MT1105
	Rail connectors	TLS-MT1106
	End caps	TLS-MT11-R-EC
	End caps	TLS-MT11-S-EC
	End caps	TLS-MT11-H-EC

Picture	Name	Model
	End caps	TLS-MT11-SR-EC
	L-shaped (Inward)	MT11-L90N-MS11
	L-shaped (Downward)	MT11-L90-MS11
	L-shaped (Inward)	MT11-L90N-MR11
	L-shaped (Downward)	MT11-L90-MR11
	L-shaped (Inward)	MT11-L90N-MH11
	L-shaped (Downward)	MT11-L90-MH11
	L-shaped (Downward)	MT11-L90-MSR11
	48V Constant Voltage Power supply(external)	BN-V48-XXXP
	48V Constant Voltage Power supply(build-in)	LV100W48CG MICRO

Note:

- 1,Please refer to the accessory list table for detailed parameters.
- 2,Different tracks need to be used with corresponding accessories

◎Packing

Model	Size (mm/box)	Quantity /box	Quantity /carton	NW (kg/box)	NW (kg/carton)	GW (kg)	Size (mm/carton)
TLS-MT11G0110(A)-XXX	95*22*165 [3.74"*0.87"*6.50"]	1	40	0.16	6.48	8.08	345*240*215 [13.58"*9.45"*8.46"]
TLS-MT11G0220(A)-XXX	95*22*235 [3.74"*0.87"*9.25"]	1	40	0.29	11.72	13.89	485*240*215 [19.09"*9.45"*8.46"]

◎Model Code

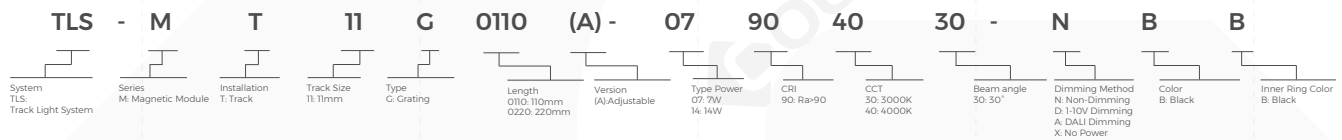

◎Attentions

- 1、 Non-professionals are prohibited from installing, disassembling and repairing the product.
- 2、 Avoid scratching, distortion and irregular bending of the product during installation; otherwise it may cause irreparable damage to the product.
- 3、 Please use professional cutting tools when cutting
- 4、 Do not use any acid or alkaline adhesive to fix products
- 5、 The product is only suitable for indoor dry places, can not be used in outdoor, seaside or wet environment.
- 6、 PC features: Each 10°C rise or drop will make diffuser extend or shrink 0.8mm/m, please confirm before processing and use